

Compensated High Current Choke, 1-phase



See below:

Approvals and Compliances

Description

- Current compensated choke
- 1-phase choke
- THT-terminals
- Flange for mounting onto printed circuit board

Unique Selling Proposition

- Compact size and light weight
- Open design optimizes heat dissipation
- Nanocrystalline (NK) or ferrite ring cores
- Customer specific pin outs available

Applications

- Frequency converter
- Charge stations
- UPS-systems
- Switching power supplies

References

Substitute for type [DKIL-1](#)

Weblinks

[pdf data sheet](#), [html datasheet](#), [General Product Information](#), [Approvals](#), [Distributor-Stock-Check](#), [Detailed request for product](#), [SPICE Library](#), [Landing Page](#)

Technical Data

Rated voltage	IEC, UL: 300VAC	Test Voltage	2500VDC, 2 sec, winding to winding	
	CSA: 250VAC		Climatic Category	40/100/21 acc. to IEC 60068-1
	max. 425VDC			Allowable Operation Temp.
Rated Current	10 - 50A @ Ta 40 °C			
Rated inductance	0.15 - 6.9mH, Tol. -30% +50%			
Power Operating Frequency	0 - 400Hz			
Terminal Type	THT			
Weight	30 - 115g			
Material	UL 94V-0			

Approvals and Compliances



Detailed information on product approvals, code requirements, usage instructions and detailed test conditions can be looked up in [Details about Approvals](#)

SCHURTER products are designed for use in industrial environments. They have approvals from independent testing bodies according to national and international standards. Products with specific characteristics and requirements such as required in the automotive sector according to IATF 16949, medical technology according to ISO 13485 or in the aerospace industry can be offered exclusively with customer-specific, individual agreements by SCHURTER.

Approvals

The approval mark is used by the testing authorities to certify compliance with the safety requirements placed on electronic products.

Approval Reference Type: DKIH-1

Approval Logo	Certificates	Certification Body	Description
	VDE Approvals	VDE	Certificate Number: 40043700
	UL Approvals	UL	UR File Number: E72928





Application standards

Application standards where the product can be used

Organization	Design	Standard	Description
	Suitable for applications acc.	IEC/UL 62368-1	Audio/video, information and communication technology equipment - Part 1: Safety requirements

Compliances

The product complies with following Guide Lines

Identification	Details	Initiator	Description
	CE declaration of conformity	SCHURTER AG	The CE marking declares that the product complies with the applicable requirements laid down in the harmonisation of Community legislation on its affixing in accordance with EU Regulation 765/2008.
	UKCA declaration of conformity	SCHURTER AG	The UKCA marking declares that the product complies with the applicable requirements laid down in the British Amendment of Regulation (EC) 765/2008.
	RoHS	SCHURTER AG	Directive RoHS 2011/65/EU, Amendment (EU) 2015/863
	China RoHS	SCHURTER AG	The law SJ / T 11363-2006 (China RoHS) has been in force since 1 March 2007. It is similar to the EU directive RoHS.
	REACH	SCHURTER AG	On 1 June 2007, Regulation (EC) No 1907/2006 on the Registration, Evaluation, Authorization and Restriction of Chemicals 1 (abbreviated as "REACH") entered into force.

Dimension [mm]

37-10

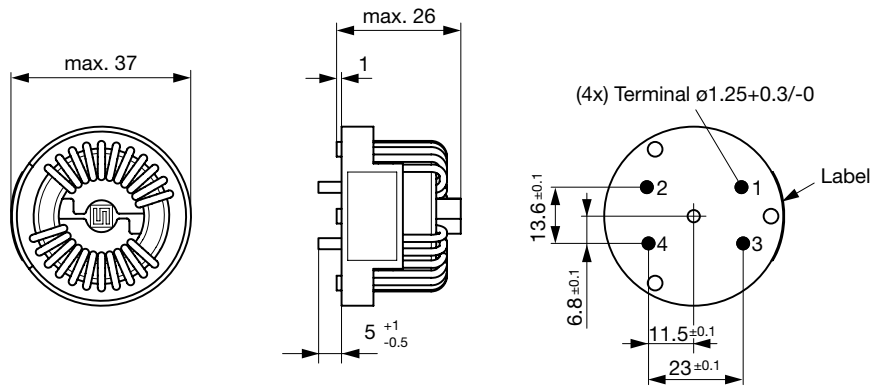

37-12

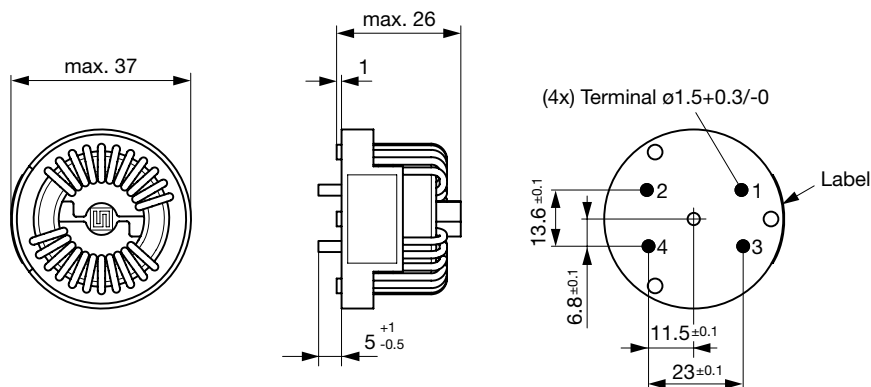

42-16

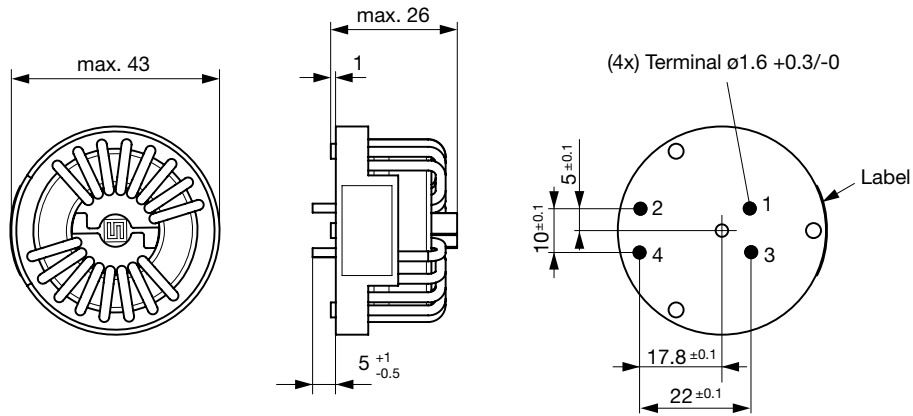

42-20

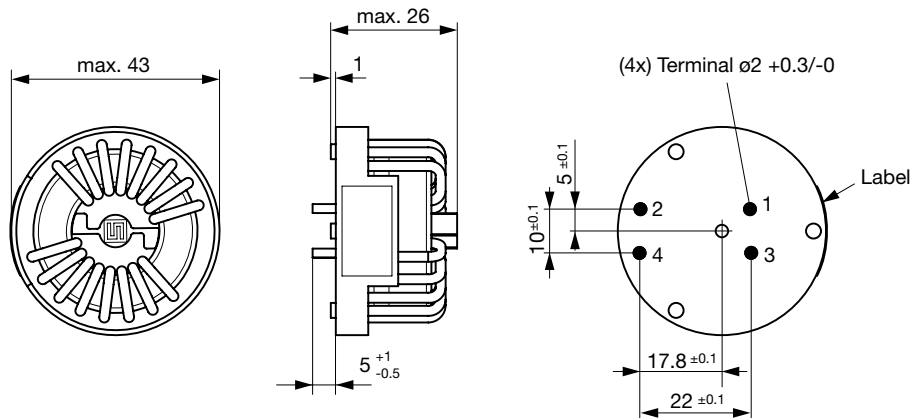

42-25

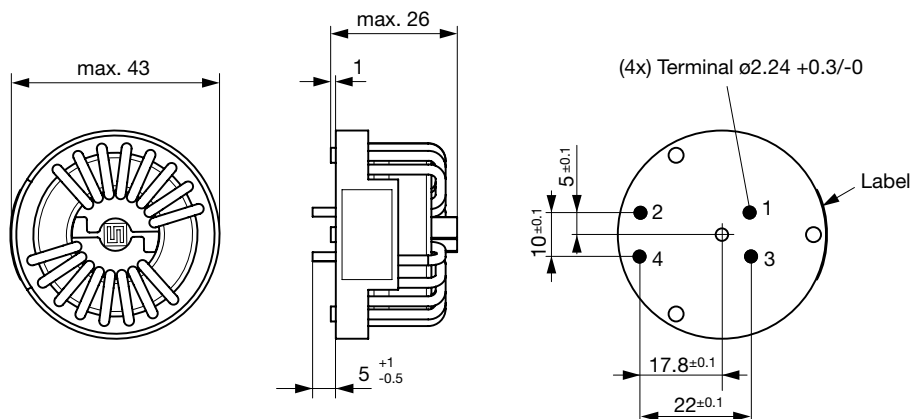

52-32

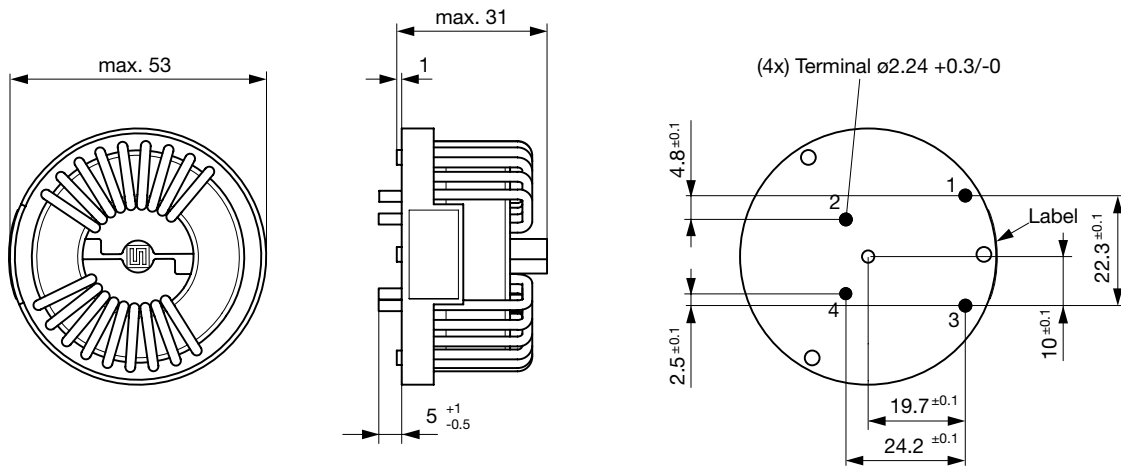

52-40

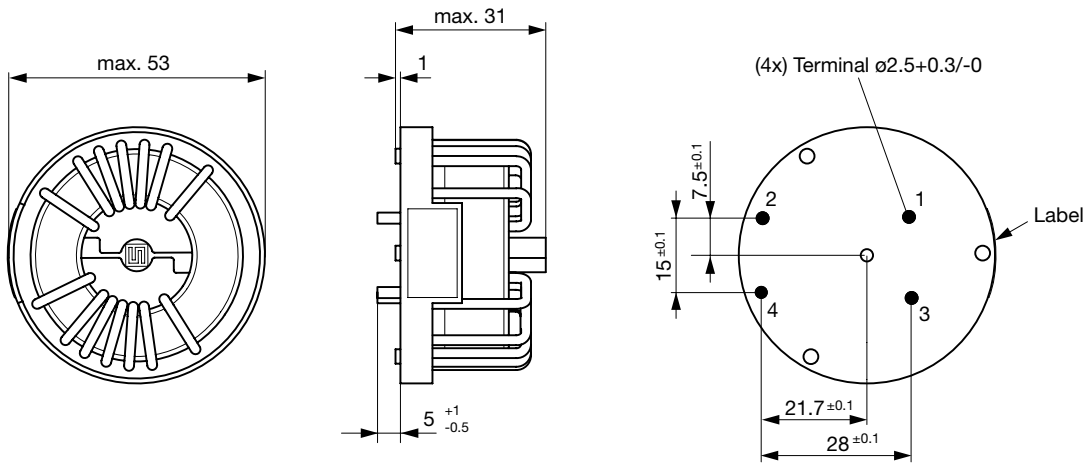

52-50

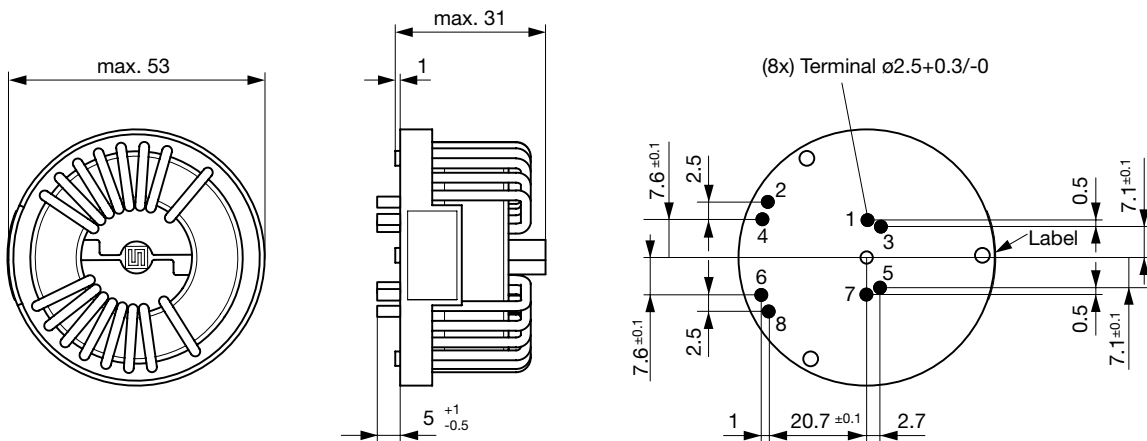

Diagrams

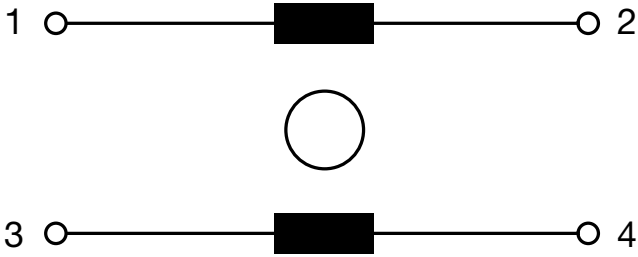

1 phase

Impedance curves

DKIH-3237-xxxx

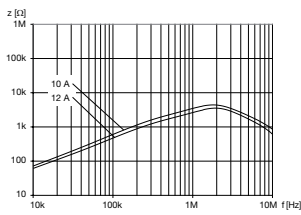

DKIH-3237-xxxx-NK

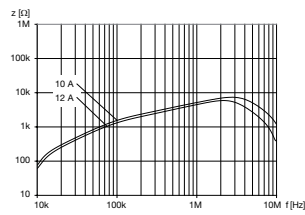

DKIH-3242-xxxx

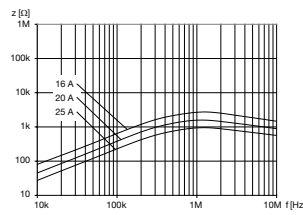

DKIH-3242-xxxx-NK

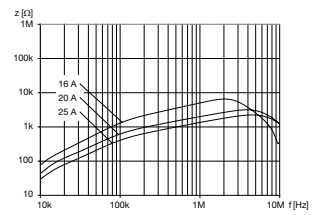

DKIH-3252-xxxx

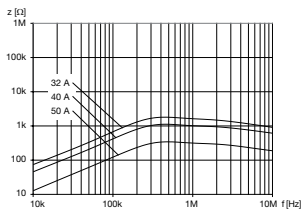

DKIH-3252-xxxx-NK

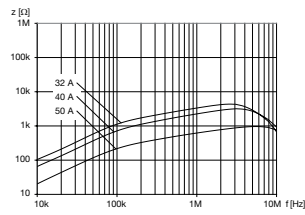

All Variants

I_n [A]	L_n [mH]	R_{cu} [mΩ]	Power Dissipation [W]	f_{RES} [MHz]	Copper ϕ [mm]	Weight [g]	Housing	Packing unit [pcs.]	Order Number
10	6.9	10	2	2.2	1.25	30 g	37-10	40	DKIH-3237-1010-NK
10	0.8	10	2	2	1.25	30 g	37-10	40	DKIH-3237-10D8
12	6.8	7	2	2.5	1.5	40 g	37-12	40	DKIH-3237-122Q-NK
12	0.7	7	2	2	1.5	40 g	37-12	40	DKIH-3237-12D7
16	6.9	5.6	2.9	2	1.6	45 g	42-16	20	DKIH-3242-160Q-NK
16	0.9	5.6	2.9	1.5	1.6	45 g	42-16	20	DKIH-3242-16D9
20	3.7	2.5	2	4	2	50 g	42-20	20	DKIH-3242-202M-NK
20	0.5	2.5	2	1.5	2	50 g	42-20	20	DKIH-3242-20D5
25	2.35	1.6	2	5	2.24	50 g	42-25	20	DKIH-3242-257K-NK
25	0.3	1.6	2	1.5	2.24	50 g	42-25	20	DKIH-3242-25D3
32	7.2	2.3	4.7	2.5	2.24	105 g	52-32	20	DKIH-3252-324Q-NK
32	0.75	2.3	4.7	0.4	2.24	105 g	52-32	20	DKIH-3252-32D8
40	4.3	1.5	4.8	3	2.5	115 g	52-40	20	DKIH-3252-409M-NK
40	0.45	1.5	4.8	0.4	2.5	115 g	52-40	20	DKIH-3252-40D5
50	1.4	0.5	2.5	6	2 x 2.5	115 g	52-50	20	DKIH-3252-506J-NK
50	0.15	0.5	2.5	0.4	2 x 2.5	115 g	52-50	20	DKIH-3252-50D2

Most Popular.

Availability for all products can be searched real-time: <https://www.schurter.com/en/info-center/support-tools/stock-check-distributors>

Accessories

Description



[EVB](#)
Evaluation Board for DKIH-1 DKIH-3 and DKIV-1