

IEC Appliance Inlet C14 or C18 with recessed Circuit Breaker TA45



Snap-in mounting from front side
 Rocker non-illuminated
 white



Screw-on version from front or rear side
 Rocker illuminated
 orange



See below:
[Approvals and Compliances](#)

Description

- Panel mount :
 Screw-on version from front or rear side, snap-in version front side
- 2 Functions :
 Appliance Inlet protection class I or II , circuit breaker type TA45 2-pole
- Quick connect terminals 6.3 x 0.8 mm

Characteristics

- All single elements are already wired
- Circuit Breaker non-illuminated or illuminated
- Suitable for use in equipment according to IEC/UL 62368-1

Other versions on request

- Unwired versions
- Other rocker marking
- Variant with notch for V-Lock mating Cordsets

References

Alternative: version with line filter [DF12](#)
 Substitute for type [6145](#)

Weblinks

[pdf data sheet](#), [html datasheet](#), [General Product Information](#), [Approvals](#), [Distributor-Stock-Check](#), [Accessories](#), [Detailed request for product](#)

Newly available variants corresponding to V-Lock mating cordset. The connector is equipped with a notch intended for use with the latching cordset. The cord latching system prevents against accidental removal of the cordset.

Technical Data

Ratings IEC	10A / 250VAC; 50Hz	Appliance inlet/-outlet	C14 / C18 acc. to IEC 60320-1, UL 60320-1, CSA C22.2 no. 60320-1 (for cold conditions) pin-temperature 70 °C, 10A, Protection Class I or II
Ratings UL/CSA	15A / 250VAC; 60Hz	Circuit Breakers	Acc. IEC/EN 60934, UL 1077, CSA 22.2 no. 235 2-pole rocker switch, illuminated or non-illuminated. Optional with undervoltage- or remote trip release Short circuit capacity Icn: at In < 3A/240VAC : 10 x In at In ≥ 3A/240VAC : 300A
Dielectric Strength	> 2.5kVAC between L-N > 3kVAC between L/N-PE (1 min/50Hz)		
Allowable Operation Temperature	-10°C to 55°C		
IP-Protection	front side IP40 acc. to IEC 60529		
Protection against electric shock	Suitable for appliances with protection class I or II acc. to IEC 61140		
Terminal	Quick connect terminals 6.3 x 0.8 mm		
Panel Thickness S	Screw: max 8 mm Mounting screw torque max 0.5Nm Snap-in: 1/1.5/2/2.5/3 mm		
Material: Housing	Thermoplastic, black, UL 94V-0		

Approvals and Compliances



Detailed information on product approvals, code requirements, usage instructions and detailed test conditions can be looked up in [Details about Approvals](#)

SCHURTER products are designed for use in industrial environments. They have approvals from independent testing bodies according to national and international standards. Products with specific characteristics and requirements such as required in the automotive sector according to IATF 16949, medical technology according to ISO 13485 or in the aerospace industry can be offered exclusively with customer-specific, individual agreements by SCHURTER.

Approvals



The approval mark is used by the testing authorities to certify compliance with the safety requirements placed on electronic products.

Approval Reference Type: DF11

Approval Logo	Certificates	Certification Body	Description
	VDE Approvals	VDE	Certificate Number: 40011305
	UL Approvals	UL	UR File Number: E96454
	CCC Approvals	CCC	CCC Certificate Number: 2020180204013620

Product standards

Product standards that are referenced

Organization	Design	Standard	Description
	Designed according to	IEC 60320-1	Appliance couplers for household and similar general purposes
	Designed according to	UL 60320-1	Standard for Attachment Plugs and Receptacles
	Designed according to	CSA C22.2 no. 60320-1	General Use Receptacles, Attachment Plugs, and Similar Wiring Devices







Application standards

Application standards where the product can be used

Organization	Design	Standard	Description
	Suitable for applications acc.	IEC/UL 62368-1	Audio/video, information and communication technology equipment - Part 1: Safety requirements

Compliances

The product complies with following Guide Lines

Identification	Details	Initiator	Description
	CE declaration of conformity	SCHURTER AG	The CE marking declares that the product complies with the applicable requirements laid down in the harmonisation of Community legislation on its affixing in accordance with EU Regulation 765/2008.
	UKCA declaration of conformity	SCHURTER AG	The UKCA marking declares that the product complies with the applicable requirements laid down in the British Amendment of Regulation (EC) 765/2008.
	RoHS	SCHURTER AG	Directive RoHS 2011/65/EU, Amendment (EU) 2015/863
	China RoHS	SCHURTER AG	The law SJ / T 11363-2006 (China RoHS) has been in force since 1 March 2007. It is similar to the EU directive RoHS.
	REACH	SCHURTER AG	On 1 June 2007, Regulation (EC) No 1907/2006 on the Registration, Evaluation, Authorization and Restriction of Chemicals 1 (abbreviated as "REACH") entered into force.
		SCHURTER AG	V-Lock system are based on a matching plug-dose combination. The connector is equipped with a notch intended for use with the latching cordset. The cord latching system prevents against accidental removal of the cordset.

Dimensions [mm]
 Screw-on mounting

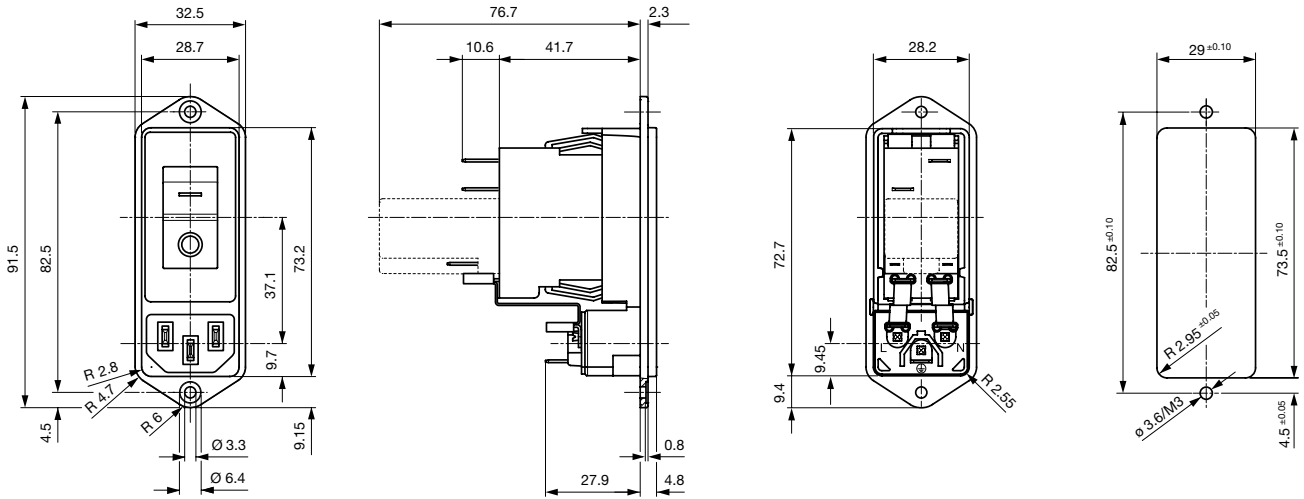

Snap-in version

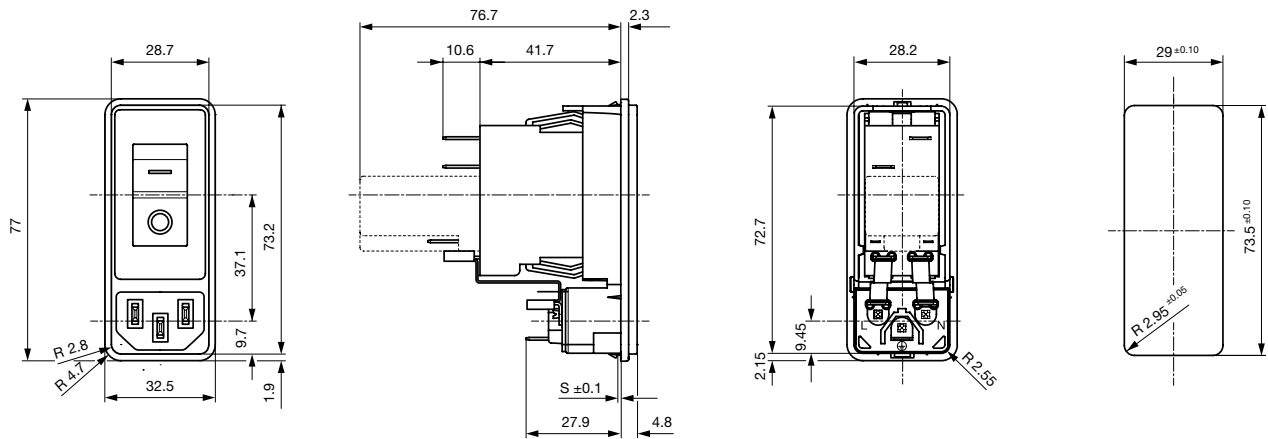

* --- Version TA45 with undervoltage release

Diagrams



1) Line
 2) Load

Effect of ambient temperature

The units are calibrated for an ambient temperature of +23°C. To determine the rated current for a lower or higher ambient temperature, use a correction factor (typical value) from the table below:

Ambient Temperature [°C]	Correction factor
-10	0.89
-5	0.91
0	0.92
+23	1.00
+30	1.03
+40	1.08
+55	1.16

Example: With a nominal current of 5A and an ambient temperature of 40°C, a correction factor of 1.08 results. This results in a nominal current of 5.5 A, which is rounded up to the next higher nominal current 6 A.

Time-Current-Curves

Tripping Characteristics $I_n < 3 A$

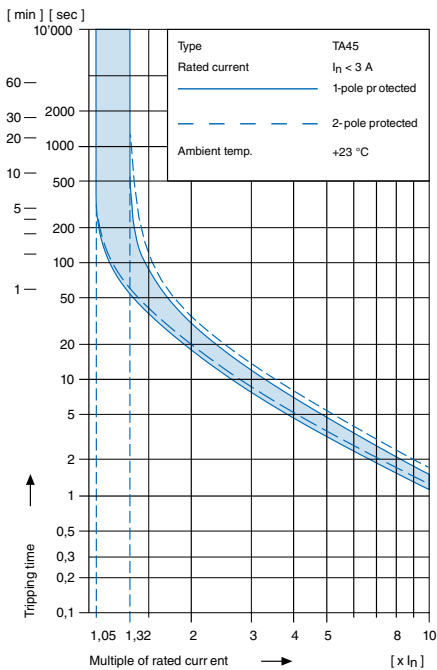

Tripping Characteristics $I_n \geq 3 \dots \leq 15 A$

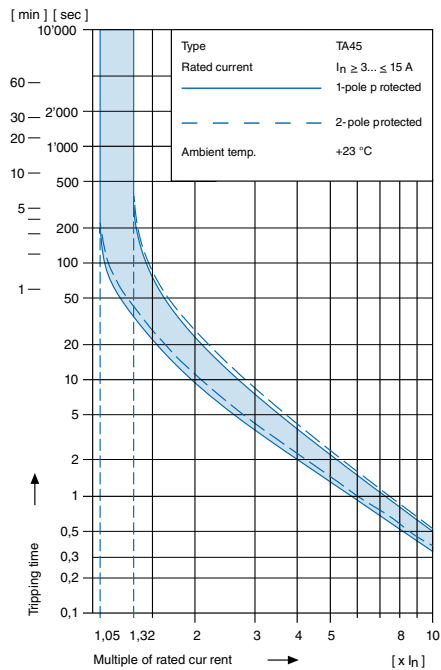

Order number key

Configuration code TA45

Type	Configuration code TA45			
DF11-	ABTWF150C0	- 000	- 111	- 009

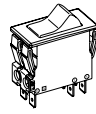

- Circuit Breaker of Equipment
 - 2-pole, rocker actuated
 - Quick connect terminal
- Other types on request

Without release: code C0

Undervoltage release

•	•	•
•	•	•
•	•	•

Remote trip release

•	2	240 V AC
•	3	230 V AC
•	4	120 V AC

Rated current circuit breaker of equipment

I_n	Code	I_n	Code	I_n	Code	I_n	Code
0,1	J01	1,3	J13	2,8	J28	10,0	100
0,2	J02	1,4	J14	3,0	030	11,0	110
0,3	J03	1,5	J15	3,5	035	12,0	120
0,4	J04	1,6	J16	4,0	040	13,0	130
0,5	J05	1,7	J17	4,5	045	14,0	140
0,6	J06	1,8	J18	5,0	050	15,0	150
0,7	J07	1,9	J19	6,0	060	20,0	200
0,8	J08	2,0	J20	6,5	065		
0,9	J09	2,1	J21	7,0	070		
1,0	J10	2,2	J22	7,5	075		
1,1	J11	2,3	J23	8,0	080		
1,2	J12	2,5	J25	9,0	090		

Rocker legend

Surface	Illustration	Colour of print	Position of the rocker legend e.g F
F embossed	— O		
H printed	ON OFF	white	
K printed	ON OFF	black	
L printed	— O	white	
M printed	— O	black	
P printed	I O	white	
R printed	I O	black	

Colours

Switch front	Rocker
W black	white
B black	black
6 black	— orange transp.

Diagram

Thermal overload protection

	1-pole	2-pole
Without illumination	ABT	ABD
With illumination	220...240 V 110...120 V	A12 A14
		A32 A34

Configuration code (Order example)

Type	Configuration code TA45		
DF11	ABTWF150C0 - 000	111	009

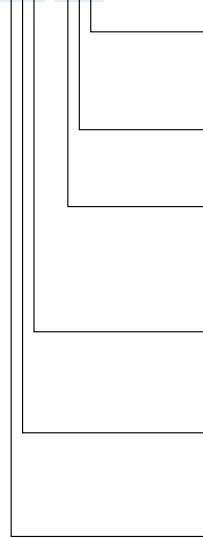

Optionale Variants

- 0 Standard
- 9 V-Lock

Colour

- 0 Black

Mounting

- 0 Screw mounting
- 1 Snap-in mounting s = 1.0 mm
- 2 Snap-in mounting s = 1.5 mm
- 3 Snap-in mounting s = 2.0 mm
- 4 Snap-in mounting s = 2.5 mm
- 5 Snap-in mounting s = 3.0 mm

Terminal PE

- 0 Without terminal (PCII)
- 1 Quick-connect terminal 6.3x0.8 mm

Terminal N

- 1 Quick-connect terminals 6.3x0.8 mm, without connection to TA45
- 3 Connection to TA45 non insulated

Terminal L

- 1 Quick-connect terminals 6.3x0.8 mm, without connection to TA45
- 3 Connection to TA45 non insulated

Packaging unit

20 Pcs

Mating Outlets/Connectors

Category / Description



[Appliance Outlet Overview complete](#)

4787, Mounting: Screw-on mounting, Appliance Outlet: IEC Solder terminals, 10 A, Suitable for appliances with protection class I	4787
IEC Appliance Outlet F or H, Screw-on Mounting, Front Side, Solder, PCB or Quick-connect Terminal	5091

[Connector Overview complete](#)



4782 Mounting: Power Cord, 3 x 1 mm ² / 3 x 18 AWG, Cable, Connector: IEC C13	4782
4785 Mounting: Power Cord, 3 x 1 mm ² / 3 x 18 AWG, Cable, Connector: IEC C13	4785
4300-06 Mounting: Power Cord, 3 x 1 mm ² / 3 x 18 AWG, Cable, Connector: IEC C13	4300-06
4781 Mounting: Power Cord, Cable, Connector: IEC C15	4781
4784 Mounting: Power Cord, 3 x 1 mm ² / 3 x 18 AWG, Cable, Connector: IEC C15	4784

Mating Outlets/Connectors shuttered



[Connector Overview complete](#)

4783 Mounting: Power Cord, 3 x 1 mm ² / 3 x 18 AWG, Cable, Connector: IEC C13	4783
--	------



[Power Cord Overview complete](#)

VAC13KS, Overview, V-Lock cord retaining, diverse Connector IEC C13, diverse, black	VAC13KS
---	---------