

Appliance inlet for low voltage, Snap-in Mounting, Front Side, Solder or Quick-connect Terminal



Snap-In Version



70° C



Description

- Panel Mount:
- Snap-in version, Frontside
- 1 Function:
- Appliance Inlet, Pin temperature 70 °C, Protection class II, Solder or Quick-Connect

References

This type is Phase-out without alternate type
Last order possibility: 31.05.2011

Weblinks

[pdf-datasheet](#), [html-datasheet](#), [General Product Information](#), [Approvals](#), [CE declaration of conformity](#), [RoHS](#), [CHINA-RoHS](#), [Mating Connectors](#), [e-Shop](#), [SCHURTER-Stock-Check](#), [Distributor-Stock-Check](#), [CAD-Drawings](#), [Accessories](#), [Mounting instruction](#), [Detailed request for product](#)

Technical Data

Ratings IEC	7 A / 48 VAC; 50 Hz
Allowable Operation Temp.	-25 °C to 70 °C
Degree of Protection	from front side IP 20 acc. to IEC 60529
Protection Class	Suitable for appliances with protection class II acc. to IEC 61140
Panel Thickness s	Snap-in version from 1 mm to 1.5 mm
Material: Housing	PA6, black / grey / white, UL 94V-0

Dimensions

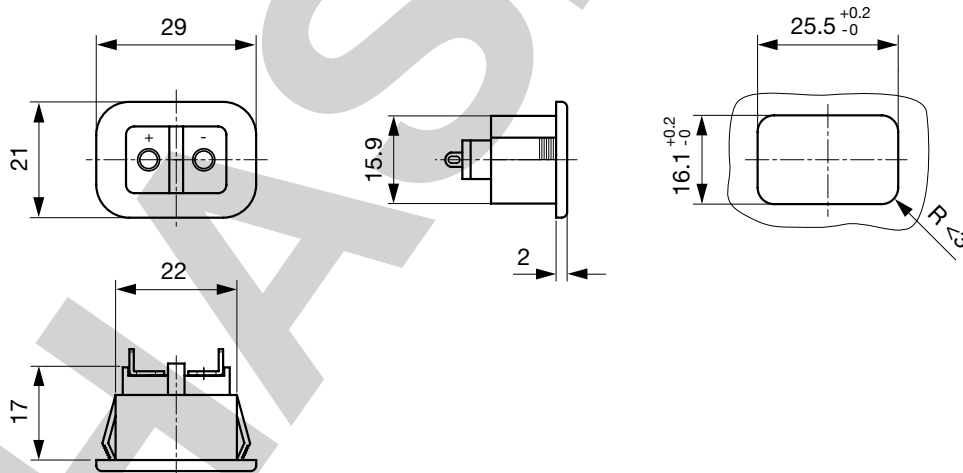

Length of the terminal please find at the order code configuration table

Dimension "X" please ref. to table order code

Config. Code







1200 - H - A B C 0 - D - E G F

The characters are placeholders for the correspondingly keys of selections from the key tables.

1200 - **H** - A B C 0 - D - E G F = Type

Type	Configuration key
protection class 1	X

1200 - H - **A** B C 0 - D - E G F = Terminals

Terminal L	Configuration key
short solder terminal (L = 4.8 mm) 	2
long solder terminal (L = 8.5 mm) 	3
PCB-terminal (standard) 	4
PCB-terminal (short) 	5
PCB-terminal (long) 	6
Blade terminal (2.8 x 0.8 mm) 	7

1200 - H - A **B** C 0 - D - E G F = Terminals

Terminal N	Configuration key
short solder terminal (L = 4.8 mm)	2
long solder terminal (L = 8.5 mm)	3
PCB-terminal (standard)	4
PCB-terminal (short)	5
PCB-terminal (long)	6
Blade terminal (2.8 x 0.8 mm)	7

Symbols similar as in table A

1200 - H - A B **C** 0 - D - E G F = Terminals

Terminal Ground	Configuration key

Symbols similar as in table A

1200 - H - A B C 0 - **D** - E G F = Color

Color	Configuration key
Black	A
Grey	B
White	D

1200 - H - A B C 0 - D - **E** G F = Style

Style	Configuration key
snap-in standard type	3

1200 - H - A B C 0 - D - E **G** F = Dimension X

Dimension "X"	Configuration key
00	

The dimension "X" is displayed in (1/10 mm). This information is also valid for the order code

1200 - H - A B C 0 - D - E G **F** = Orientation of Terminals

Orientation of Terminals	Configuration key
horizontal	A
vertical	B
vertical right	C

Packaging unit 100 Pcs

Mating Outlets/Connectors

Category / Description



[Interconnection Cord Overview complete](#)

Interconnection Cord with Appliance Outlet For low voltage, Straight

1250

[Interconnection Cord further types to 1200](#)